









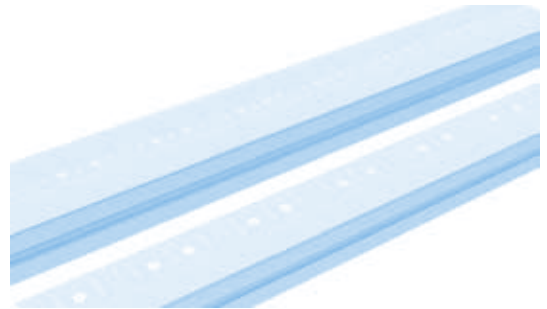
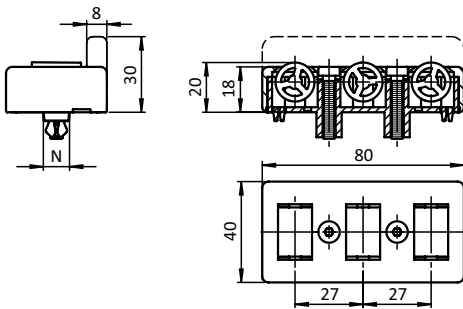

ROLLENELEMENT, SCHRAUBBAR

ROLLER ELEMENT, SCREW-ON VERSION

Ausführung	ohne Nut, Nut 8, Nut 10	Model	Without slot, slot 8, slot 10
Beschreibung	zur Herstellung von Rollenbahnen in beliebiger Breite und Länge, inkl. 2 Schrauben M5 × 25	Description	For manufacturing roller conveyors in any width and length, incl. 2 Screws M5 × 25
Material	Gehäuse: Kunststoff PA, glaskugelverstärkt Rollen: Kunststoff POM Montageset: Stahl	Material	Casing: Plastic PA, glass ball reinforced Rollers: Plastic POM Assembly set: Steel
Farbe	schwarz	Color	Black
Befestigung	Variante 1 (mit Klemmhammer): durch Einschrauben oder Einschlagen von 2 Schrauben M5 × 25 Variante 2 (ohne Klemmhammer): mit 2 Schrauben M5 × 25 und Nutensteinen oder Hammermuttern	Fastening	Version 1 (with clamp hammer): to be fastened with 2 screw-in or knock-in screws M5 × 25 Version 2 (without clamp hammer): using 2 screws M5 × 25 and T-slot nuts or hammer nuts
Montageset 2	2 Hammermuttern Nut 10 - M5	Assembly Set 2	2 hammer nuts lot 10 - M5
Liefereinheit	10 Stück	Pack Quantity	10 pieces
Hinweis	*  elektrostatisch entladende Ausführung wird ohne Klemmhammer geliefert, zur Montage mit  elektrostatisch entladenden Hammermuttern oder Nutensteinen	Tip	*  delivery of electrostatically discharging version without clamp hammer, to fasten with  electrostatically discharging hammer nuts or T-slot nuts



Rollenelement, schraubbar Roller Element, Screw-on Version	Montageset	N	ESD	Gewicht [g] Weight [g]	Profil Profile	Teil-Nr. Part #
ohne Seitenführung Without lateral guide	- / 8 / 10			53.0		09309302
	- / 8 / 10			54.5		* 09309302S01
inkl. Montageset 1 With assembly set 1		8		62.0	I	* 09309302S03
		10		70.0	B	* 09309302S02
mit Seitenführung With lateral guide	- / 8 / 10			59.0		09309304
	- / 8 / 10			61.5		* 09309304S01
inkl. Montageset 1 With assembly set 1		8		69.0	I	* 09309304S04
		10		77.0	B	* 09309304S03